

IRG4BC20UDPbF

INSULATED GATE BIPOLAR TRANSISTOR WITH ULTRAFAST
 SOFT RECOVERY DIODE

UltraFast CoPack IGBT

Features

- UltraFast: optimized for high operating frequencies 8-40 kHz in hard switching, >200 kHz in resonant mode
- Generation 4 IGBT design provides tighter parameter distribution and higher efficiency than Generation 3
- IGBT co-packaged with HEXFRED® ultrafast, ultra-soft-recovery anti-parallel diodes for use in bridge configurations
- Industry standard TO-220AB package
- Lead-Free

Benefits

- Generation -4 IGBTs offer highest efficiencies available
- IGBTs optimized for specific application conditions
- HEXFRED diodes optimized for performance with IGBTs. Minimized recovery characteristics require less/no snubbing
- Designed to be a "drop-in" replacement for equivalent industry-standard Generation 3 IR IGBTs

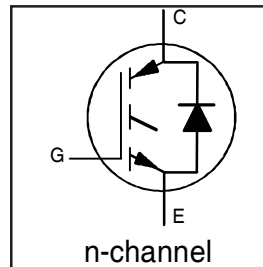

| |
|------------------------------|
| $V_{CES} = 600V$ |
| $V_{CE(on) typ.} = 1.85V$ |
| @ $V_{GE} = 15V, I_C = 6.5A$ |

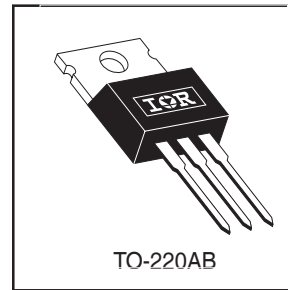

Absolute Maximum Ratings

| | Parameter | Max. | Units |
|---------------------------|--|---------------------|------------|
| V_{CES} | Collector-to-Emitter Voltage | 600 | V |
| $I_C @ T_C = 25^\circ C$ | Continuous Collector Current | 13 | A |
| $I_C @ T_C = 100^\circ C$ | Continuous Collector Current | 6.5 | |
| I_{CM} | Pulsed Collector Current ① | 52 | |
| I_{LM} | Clamped Inductive Load Current ② | 52 | |
| $I_F @ T_C = 100^\circ C$ | Diode Continuous Forward Current | 7.0 | |
| I_{FM} | Diode Maximum Forward Current | 52 | |
| V_{GE} | Gate-to-Emitter Voltage | ± 20 | V |
| $P_D @ T_C = 25^\circ C$ | Maximum Power Dissipation | 60 | W |
| $P_D @ T_C = 100^\circ C$ | Maximum Power Dissipation | 24 | |
| T_J | Operating Junction and Storage Temperature Range | -55 to +150 | $^\circ C$ |
| T_{STG} | | | |
| | | | |
| | Mounting Torque, 6-32 or M3 Screw. | 10 lbf•in (1.1 N•m) | |

Thermal Resistance

| | Parameter | Min. | Typ. | Max. | Units |
|-----------------|---|-------|----------|-------|--------------|
| $R_{\theta JC}$ | Junction-to-Case - IGBT | ----- | ----- | 2.1 | $^\circ C/W$ |
| $R_{\theta JC}$ | Junction-to-Case - Diode | ----- | ----- | 3.5 | |
| $R_{\theta CS}$ | Case-to-Sink, flat, greased surface | ----- | 0.50 | ----- | |
| $R_{\theta JA}$ | Junction-to-Ambient, typical socket mount | ----- | ----- | 80 | |
| Wt | Weight | ----- | 2 (0.07) | ----- | g (oz) |

IRG4BC20UDPbF

Electrical Characteristics @ T_J = 25°C (unless otherwise specified)

| | Parameter | Min. | Typ. | Max. | Units | Conditions |
|--|---|------|------|------|-------|--|
| V _{(BR)CES} | Collector-to-Emitter Breakdown Voltage ^③ | 600 | ---- | ---- | V | V _{GE} = 0V, I _C = 250μA |
| ΔV _{(BR)CES} /ΔT _J | Temperature Coeff. of Breakdown Voltage | ---- | 0.69 | ---- | V/°C | V _{GE} = 0V, I _C = 1.0mA |
| V _{CE(on)} | Collector-to-Emitter Saturation Voltage | ---- | 1.85 | 2.1 | V | I _C = 6.5A V _{GE} = 15V |
| | | ---- | 2.27 | ---- | | I _C = 13A See Fig. 2, 5 |
| | | ---- | 1.87 | ---- | | I _C = 6.5A, T _J = 150°C |
| V _{GE(th)} | Gate Threshold Voltage | 3.0 | ---- | 6.0 | | V _{CE} = V _{GE} , I _C = 250μA |
| ΔV _{GE(th)} /ΔT _J | Temperature Coeff. of Threshold Voltage | ---- | -11 | ---- | mV/°C | V _{CE} = V _{GE} , I _C = 250μA |
| g _{fe} | Forward Transconductance ^④ | 1.4 | 4.3 | ---- | S | V _{CE} = 100V, I _C = 6.5A |
| I _{CES} | Zero Gate Voltage Collector Current | ---- | ---- | 250 | μA | V _{GE} = 0V, V _{CE} = 600V |
| | | ---- | ---- | 1700 | | V _{GE} = 0V, V _{CE} = 600V, T _J = 150°C |
| V _{FM} | Diode Forward Voltage Drop | ---- | 1.4 | 1.7 | V | I _C = 8.0A See Fig. 13 |
| | | ---- | 1.3 | 1.6 | | I _C = 8.0A, T _J = 150°C |
| I _{GES} | Gate-to-Emitter Leakage Current | ---- | ---- | ±100 | nA | V _{GE} = ±20V |

Switching Characteristics @ T_J = 25°C (unless otherwise specified)

| | Parameter | Min. | Typ. | Max. | Units | Conditions |
|--------------------------|---|------|------|------|-------|--|
| Q _g | Total Gate Charge (turn-on) | ---- | 27 | 41 | nC | I _C = 6.5A |
| Q _{ge} | Gate - Emitter Charge (turn-on) | ---- | 4.5 | 6.8 | | V _{CC} = 400V See Fig. 8 |
| Q _{gc} | Gate - Collector Charge (turn-on) | ---- | 10 | 16 | | V _{GE} = 15V |
| t _{d(on)} | Turn-On Delay Time | ---- | 39 | ---- | ns | T _J = 25°C |
| t _r | Rise Time | ---- | 15 | ---- | | I _C = 6.5A, V _{CC} = 480V |
| t _{d(off)} | Turn-Off Delay Time | ---- | 93 | 140 | | V _{GE} = 15V, R _G = 50Ω |
| t _f | Fall Time | ---- | 110 | 170 | | Energy losses include "tail" and diode reverse recovery. |
| E _{on} | Turn-On Switching Loss | ---- | 0.16 | ---- | mJ | See Fig. 9, 10, 11, 18 |
| E _{off} | Turn-Off Switching Loss | ---- | 0.13 | ---- | | |
| E _{ts} | Total Switching Loss | ---- | 0.29 | 0.3 | | |
| t _{d(on)} | Turn-On Delay Time | ---- | 38 | ---- | ns | T _J = 150°C, See Fig. 9, 10, 11, 18 |
| t _r | Rise Time | ---- | 17 | ---- | | I _C = 6.5A, V _{CC} = 480V |
| t _{d(off)} | Turn-Off Delay Time | ---- | 100 | ---- | | V _{GE} = 15V, R _G = 50Ω |
| t _f | Fall Time | ---- | 220 | ---- | | Energy losses include "tail" and diode reverse recovery. |
| E _{ts} | Total Switching Loss | ---- | 0.49 | ---- | mJ | |
| L _E | Internal Emitter Inductance | ---- | 7.5 | ---- | nH | Measured 5mm from package |
| C _{ies} | Input Capacitance | ---- | 530 | ---- | pF | V _{GE} = 0V |
| C _{oes} | Output Capacitance | ---- | 39 | ---- | | V _{CC} = 30V See Fig. 7 |
| C _{res} | Reverse Transfer Capacitance | ---- | 7.4 | ---- | | f = 1.0MHz |
| t _{rr} | Diode Reverse Recovery Time | ---- | 37 | 55 | ns | T _J = 25°C See Fig. 14 |
| | | ---- | 55 | 90 | | T _J = 125°C |
| I _{rr} | Diode Peak Reverse Recovery Current | ---- | 3.5 | 5.0 | A | T _J = 25°C See Fig. 15 |
| | | ---- | 4.5 | 8.0 | | T _J = 125°C |
| Q _{rr} | Diode Reverse Recovery Charge | ---- | 65 | 138 | nC | T _J = 25°C See Fig. 16 |
| | | ---- | 124 | 360 | | T _J = 125°C |
| di _{(rec)M} /dt | Diode Peak Rate of Fall of Recovery During t _b | ---- | 240 | ---- | A/μs | T _J = 25°C See Fig. 17 |
| | | ---- | 210 | ---- | | T _J = 125°C |

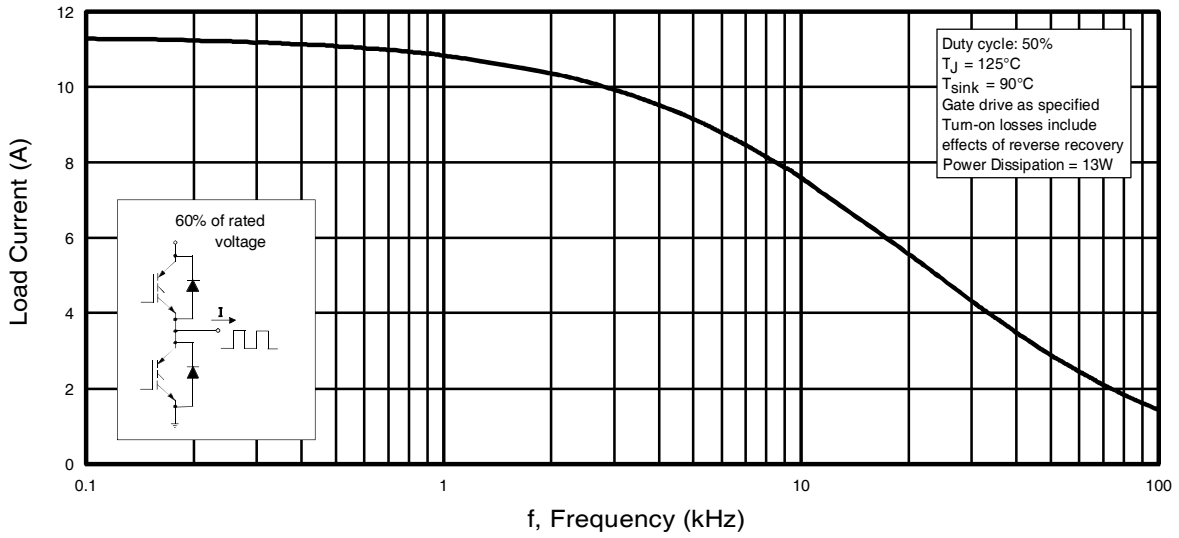

Fig. 1 - Typical Load Current vs. Frequency
 (Load Current = I_{RMS} of fundamental)

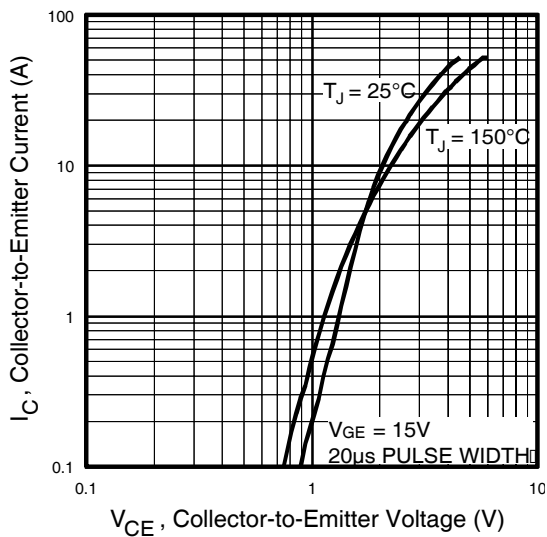

Fig. 2 - Typical Output Characteristics

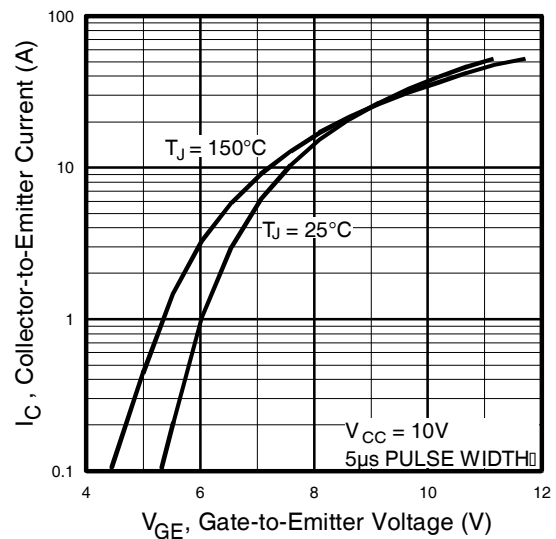

Fig. 3 - Typical Transfer Characteristics

IRG4BC20UDPbF

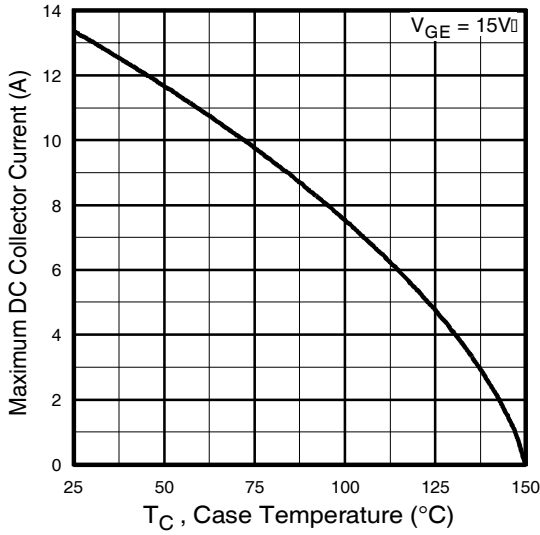

Fig. 4 - Maximum Collector Current vs. Case Temperature

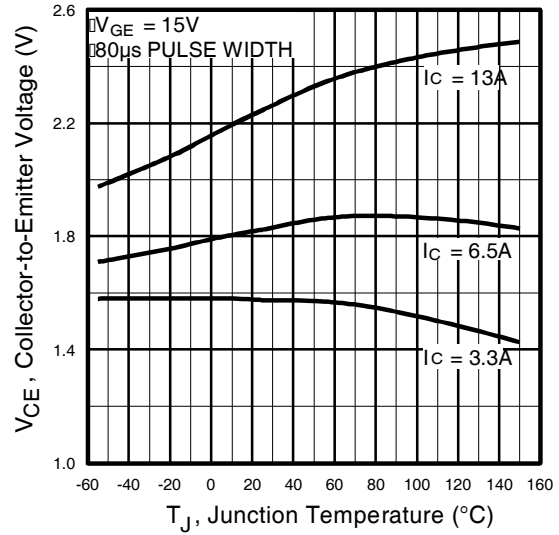

Fig. 5 - Typical Collector-to-Emitter Voltage vs. Junction Temperature

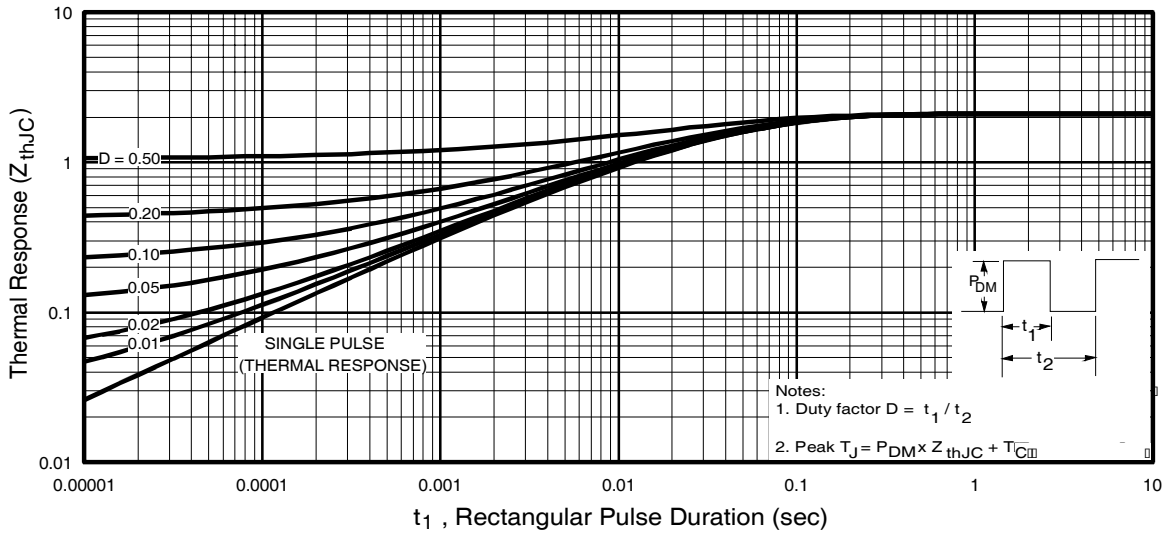

Fig. 6 - Maximum IGBT Effective Transient Thermal Impedance, Junction-to-Case

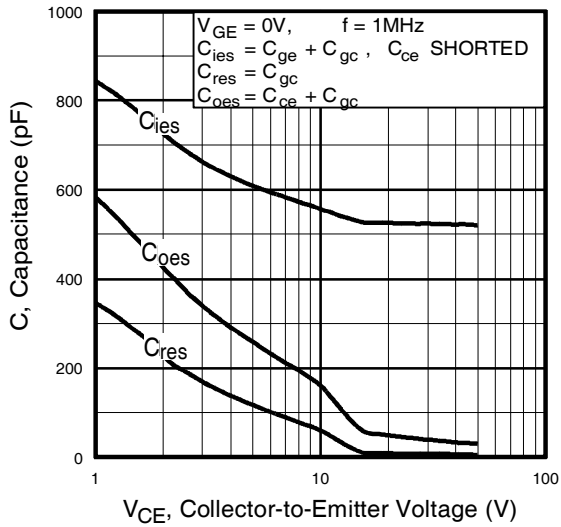

Fig. 7 - Typical Capacitance vs. Collector-to-Emitter Voltage

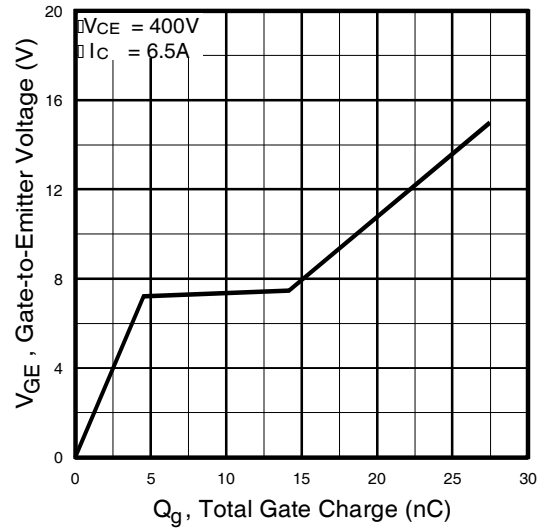

Fig. 8 - Typical Gate Charge vs. Gate-to-Emitter Voltage

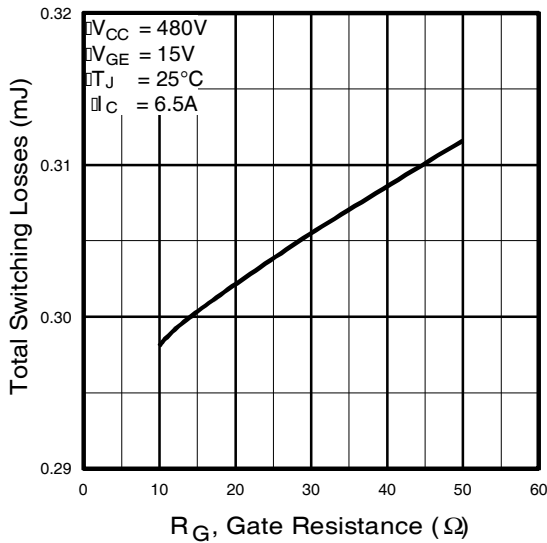

Fig. 9 - Typical Switching Losses vs. Gate Resistance

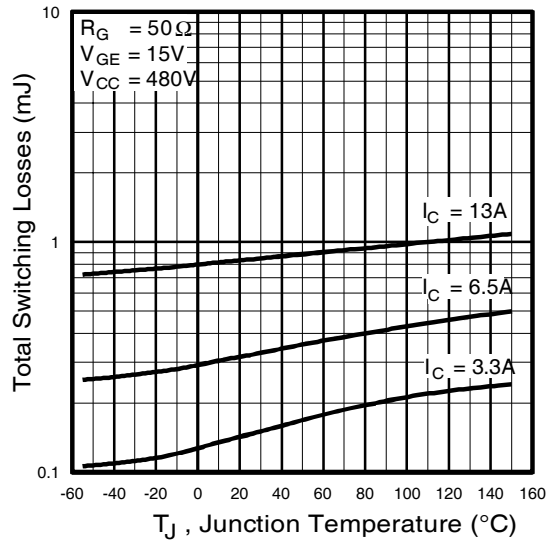

Fig. 10 - Typical Switching Losses vs. Junction Temperature

IRG4BC20UDPbF

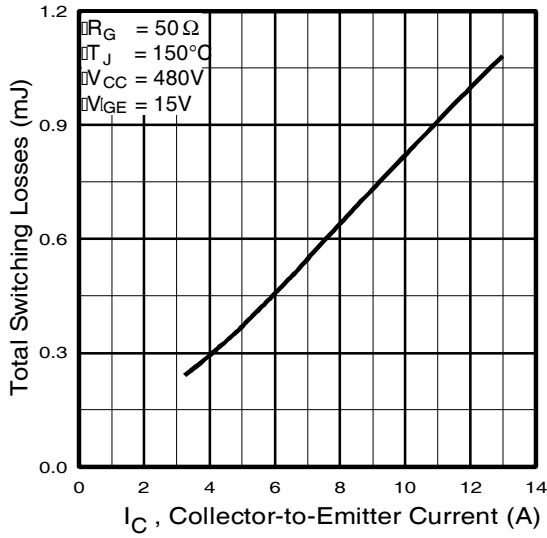

Fig. 11 - Typical Switching Losses vs. Collector-to-Emitter Current

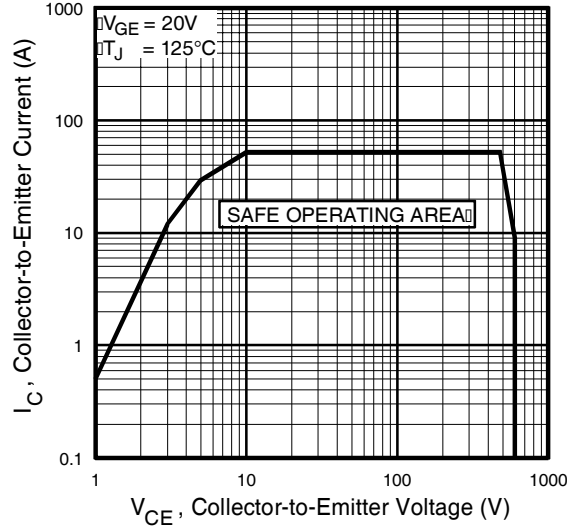

Fig. 12 - Turn-Off SOA

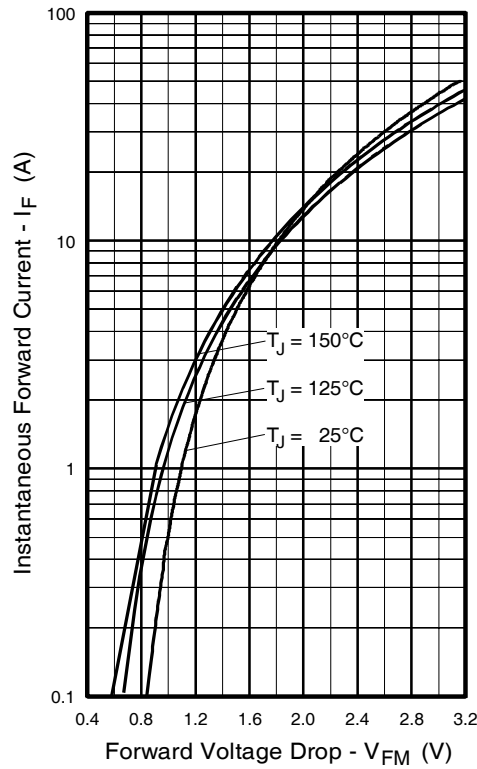

Fig. 13 - Maximum Forward Voltage Drop vs. Instantaneous Forward Current

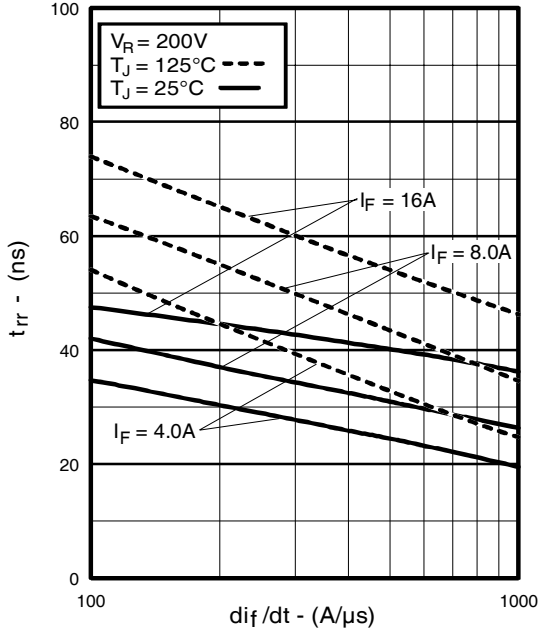

Fig. 14 - Typical Reverse Recovery vs. di_f/dt

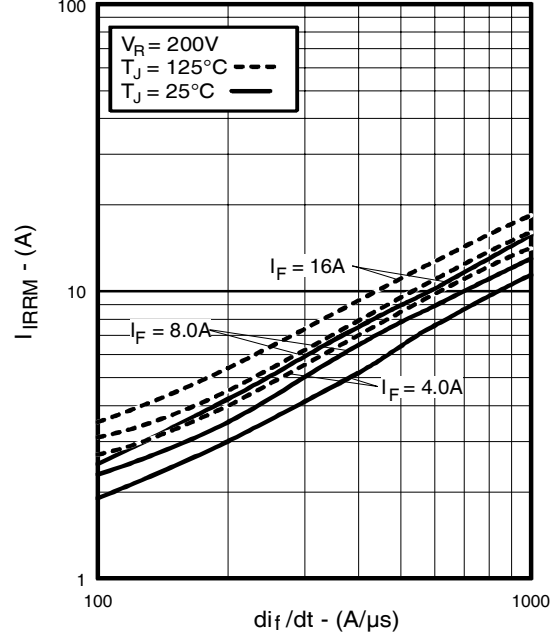

Fig. 15 - Typical Recovery Current vs. di_f/dt

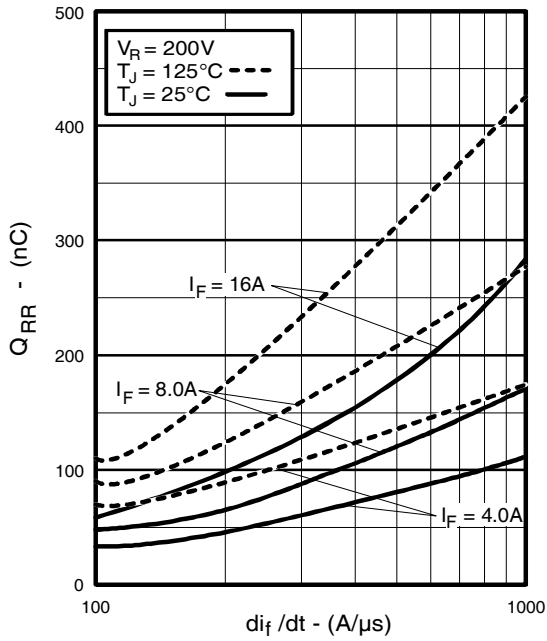

Fig. 16 - Typical Stored Charge vs. di_f/dt
www.irf.com

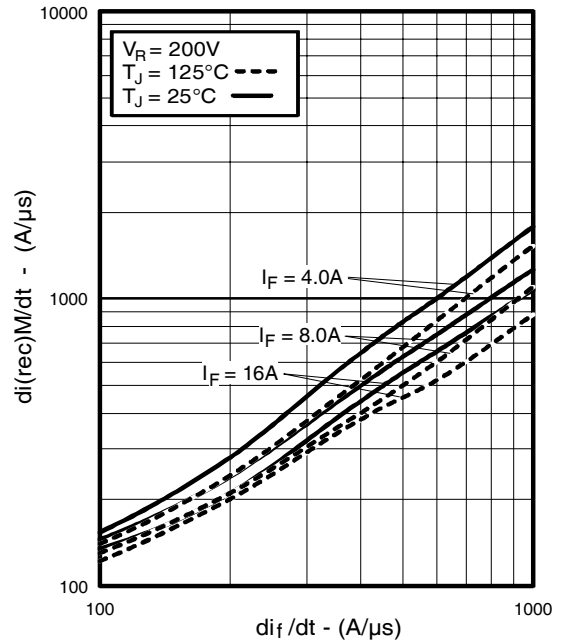

Fig. 17 - Typical $di_{(rec)M}/dt$ vs. di_f/dt

IRG4BC20UDPbF

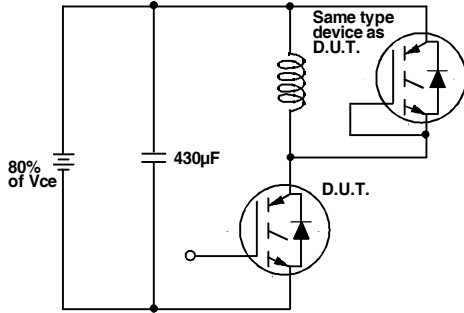

Fig. 18a - Test Circuit for Measurement of I_{LM} , E_{on} , $E_{off}(\text{diode})$, t_{rr} , Q_{rr} , I_{rr} , $t_{d(on)}$, t_r , $t_{d(off)}$, t_f

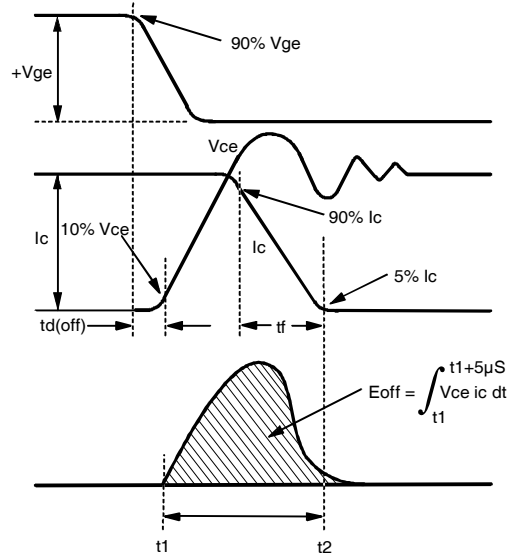

Fig. 18b - Test Waveforms for Circuit of Fig. 18a, Defining E_{off} , $t_{d(off)}$, t_f

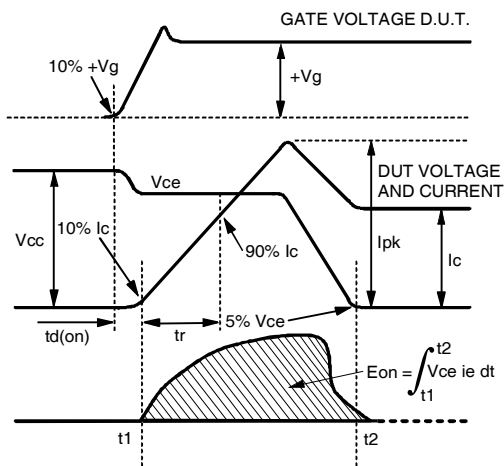

Fig. 18c - Test Waveforms for Circuit of Fig. 18a, Defining E_{on} , $t_{d(on)}$, t_r

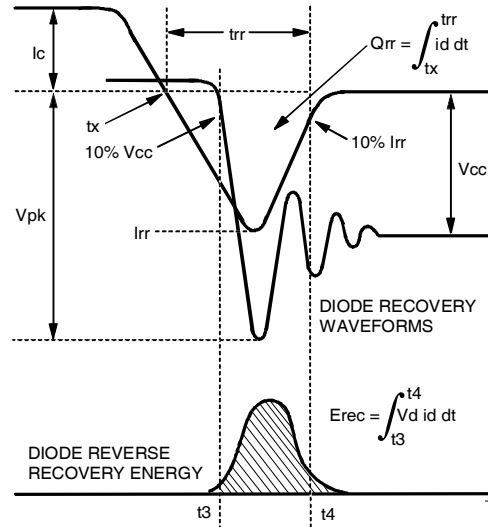

Fig. 18d - Test Waveforms for Circuit of Fig. 18a, Defining E_{rec} , t_{rr} , Q_{rr} , I_{rr}

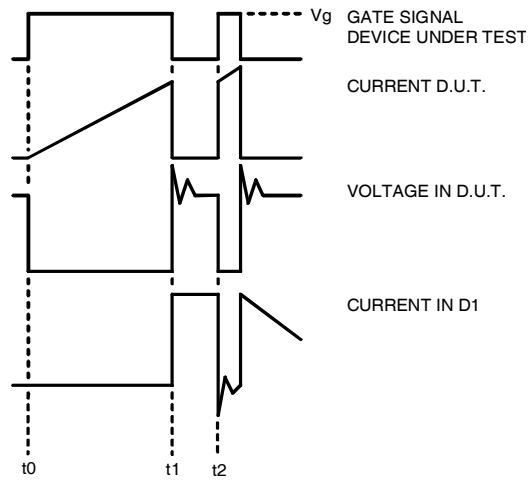

Figure 18e. Macro Waveforms for Figure 18a's Test Circuit



Figure 19. Clamped Inductive Load Test Circuit

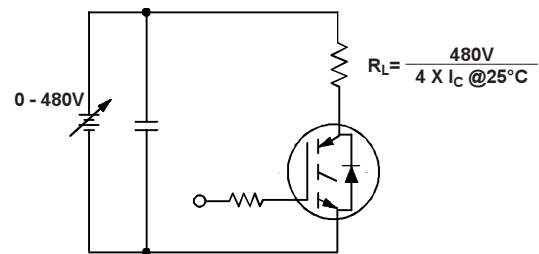

Figure 20. Pulsed Collector Current Test Circuit

IRG4BC20UDPbF

Notes:

- ① Repetitive rating: $V_{GE}=20V$; pulse width limited by maximum junction temperature (figure 20)
- ② $V_{CC}=80\%(V_{CES})$, $V_{GE}=20V$, $L=10\mu H$, $R_G=50\Omega$ (figure 19)
- ③ Pulse width $\leq 80\mu s$; duty factor $\leq 0.1\%$.
- ④ Pulse width 5.0 μs , single shot.

TO-220AB Package Outline

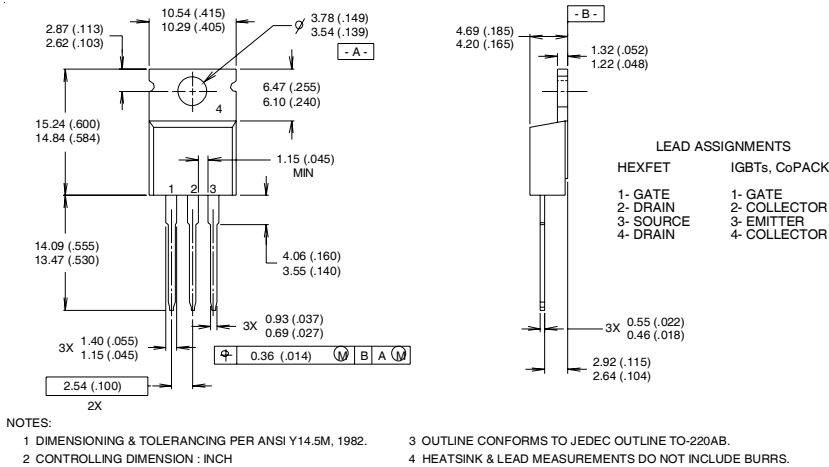

TO-220AB Part Marking Information

EXAMPLE: THIS IS AN IRF1010
 LOT CODE 1789
 ASSEMBLED ON WW 19, 1997
 IN THE ASSEMBLY LINE "C"
Note: "P" in assembly line position indicates "Lead-Free"

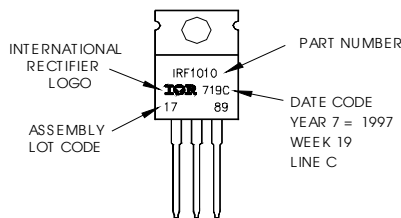

Data and specifications subject to change without notice.

Note: For the most current drawings please refer to the IR website at:
<http://www.irf.com/package/>